



www.GlomacAmerica.com

Goodwin

**SUBMERSIBLE
PUMPS**

NUMBER ONE
FOR RELIABILITY, STRENGTH & ENDURANCE



www.GlomacAmerica.com



www.GlomacAmerica.com

Goodwin

SUBMERSIBLE PUMPS

USED AROUND THE WORLD IN THE TOUGHEST ENVIRONMENTS

GOLD MINING

tailings disposal and extraction
plant pumping

DIAMOND MINING

dredging and separation plant

COAL MINING

wash plants and open
pit mine dewatering

THERMAL POWER

coal and ash handling

COPPER MINING

tailings management and
extraction plant pumping

AGRICULTURE

irrigation and animal
waste pumping

IRON ORE MINING

tailings management and
extraction plant pumping

MINE TAILINGS DAM MANAGEMENT

remediation and reprocessing

HYDROELECTRIC POWER

lagoon dredging and silt removal

STEELMAKING

iron ore slurry management and
mill scale transport

HARBOUR AND DOCK CLEANING

silt removal

ALUMINA PRODUCTION

hydroxide and tailings pumping

SEWAGE AND WASTE TRANSFER

management & removal

FISHING PONDS AND LAKES

silt removal

WATERCOURSE MANAGEMENT

river dredging and silt removal

CONSTRUCTION

pit dewatering



www.GlomacAmerica.com



www.GlomacAmerica.com



Contents

Goodwin Pump Overview	pg 1
Electric Slurry Pumps	pg 3
Electric Dirty Water High Head Pumps	pg 9
Acid Resistant Electric Slurry Pump	pg 11
Pontoons	pg 13
Accessories	pg 17
Pump Selection Data	pg 19
Installation & Operation Best Practice	pg 21
Workshop & Repairs	pg 25

PUMPS FOR THE MOST DEMANDING APPLICATIONS

snorkel

Xtreme

wheelwash

GLOBE

SUMMIT

Goodwin

Gallogas

cascade

KLARIVISION

ROBUSTEC

www.GlomacAmerica.com



www.GlomacAmerica.com

Goodwin

Submersible Pump Product Range

Goodwin submersible pumps have been manufactured since 1982 and are recognised as market leaders in terms of performance and reliability.

The pumps have been continually developed over four decades to enhance strength and endurance. Goodwin pumps deliver proven performance in the most demanding environments.

Goodwin submersible pumps is a truly global business with operations covering the world. Engineering excellence is built into all that Goodwin does.

Electric Slurry Pumps



100mm Discharge
30kW Motor
730kg

150mm Discharge
55kW Motor
745kg

150mm Discharge
90kW Motor
2050kg

	100 NZE	100 ANZE®	100 HNZN	150 DACT	150 NZE	150 ANZE®	150 HNZN	200 NZE
Max solid content (by weight)	65	65	25	65	65	65	40	65
Max slurry specific gravity (kg/l)	2.8	2.8	1.5	2.8	2.5	2.1	1.5	2.5
Max particle size (mm)	25	32	12	37	54	45	30	76
Max slurry temperature (°C)	90	90	90	90	90	90	90	90
Max flow (m³/h)	137	220	160	180	380	500	460	600
Max head (m) (pressure bar)	33 (3.2)	38 (3.7)	60 (5.9)	38 (3.7)	25 (2.4)	40 (3.9)	53 (5.2)	27 (2.6)
Max submergence depth* (m)	28	28	28	28	28	28	28	28
Minimum sump size based on pump dimensions** (length x width x depth) (m)	(l) 2 (w) 1.5 (d) 2	(l) 2 (w) 1.5 (d) 2	(l) 2 (w) 1.5 (d) 2	(l) 2 (w) 1.5 (d) 2	(l) 2.5 (w) 2 (d) 2.5	(l) 2.5 (w) 2 (d) 2.5	(l) 2.5 (w) 2 (d) 2.5	(l) 3 (w) 2.5 (d) 3
Sump dead zone** (bottom)	0.35	0.35	0.35	0.35	0.4	0.4	0.4	0.45

* 28m as standard, can be deeper if required

** See page 21+22 for more information



www.GlomacAmerica.com



www.GlomacAmerica.com

Electric High Head Pumps

Electric Acid Resistant Pumps



200 ESP

200mm Discharge
112kW Motor
2375kg



100 DWHH

150 DWHH

100mm Discharge
90kW Motor
1940kg

150mm Discharge
150kW Motor
2750kg



100 SDSS

100mm Discharge
30kW Motor
770kg

200 ANZE®	200 HNZE	100 DWHH	150 DWHH	100 SDSS ANZE®
65	40	10	10	65
2.1	1.5	1.1	1.1	2.8
76	40	10	10	32
90	90	90	90	90
800	800	195	195	220
40 (3.9)	53 (5.2)	130 (12.8)	190 (18.6)	38 (3.7)
28	28	28	28	28
(l) 3 (w) 2.5 (d) 3	(l) 3 (w) 2.5 (d) 3	(l) 2.5 (w) 2 (d) 2.5	(l) 2.5 (w) 2 (d) 2.5	(l) 2 (w) 1.5 (d) 2
0.45	0.45	0.42	0.56	0.35

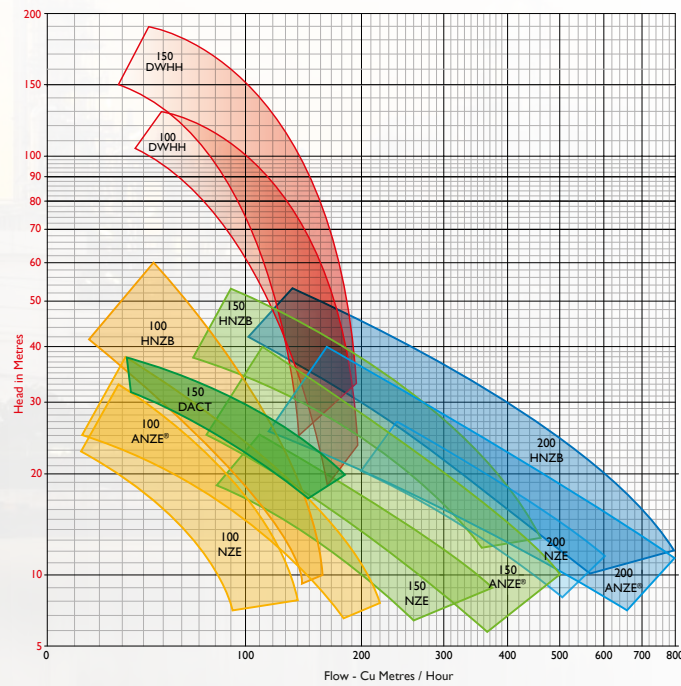

www.GlomacAmerica.com



ELECTRIC SUBMERSIBLE SLURRY PUMPS

Goodwin heavy duty slurry pumps are designed with outstanding features that guarantee exceptional performance. Precision engineering and robust construction gives reliable operation in the most demanding conditions.



3 Sizes

100mm, 150mm, 200mm

5 Motors

22kW, 30kW, 55kW, 90kW, 112kW

4 Configurations

NZE, ANZE, HNZZ, DACT

Twin Volute Casing

Goodwin use a Twin Volute casing to balance the load on the shaft when pumping variable density slurry. A traditional single volute design can put uneven loads on the rotating elements of the pump leading to premature failure in service.

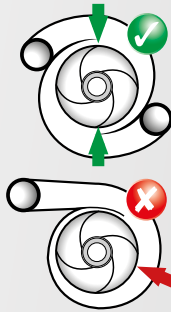

Inducer Effect

The Goodwin Inducer sends hydrodynamic shock waves below the pump which makes settled solids start to flow.

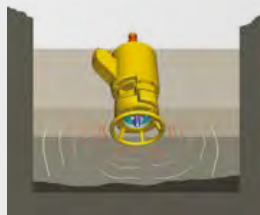

Removable Discharge Elbow

The 150 and 200mm Goodwin Pumps are supplied with a removable and replaceable discharge elbow made from precipitation hardened stainless steel.

Non-Pressurised Mechanical Seal

Suitable for submergence depth up to 28 metres as standard. The Goodwin mechanical seal is only subjected to the pressure from the submergence depth of the pump which generally is only a few metres of head and not the discharge pressure of the product. This greatly reduces the chance of fluid ingress into the motor itself and the destructive consequences which can result. The seal is positioned directly below the lower bearing to give it maximum support and protection from vibration.

Heavy Duty Wet-End Parts

The wet end of all Goodwin submersible slurry pumps are made of NiHard alloy. For very abrasive applications Goodwin can offer tungsten carbide coated impellers, inducers and wear plates as it is possible to coat 100% of the rotating surface exposed to the slurry and thus provide the customer with excellent component life. 150 and 200 size slurry pumps have tungsten carbide coated wet end parts as standard. For 100 size pumps, coating is optional.

Open Vane Impeller

This feature assists the breakdown of large particles in the impeller that might ultimately lead to a blocked pump. There is little if any chance of the impeller becoming blocked as opposed to closed vane impellers which are often blocked and tend to stay blocked.





Goodwin

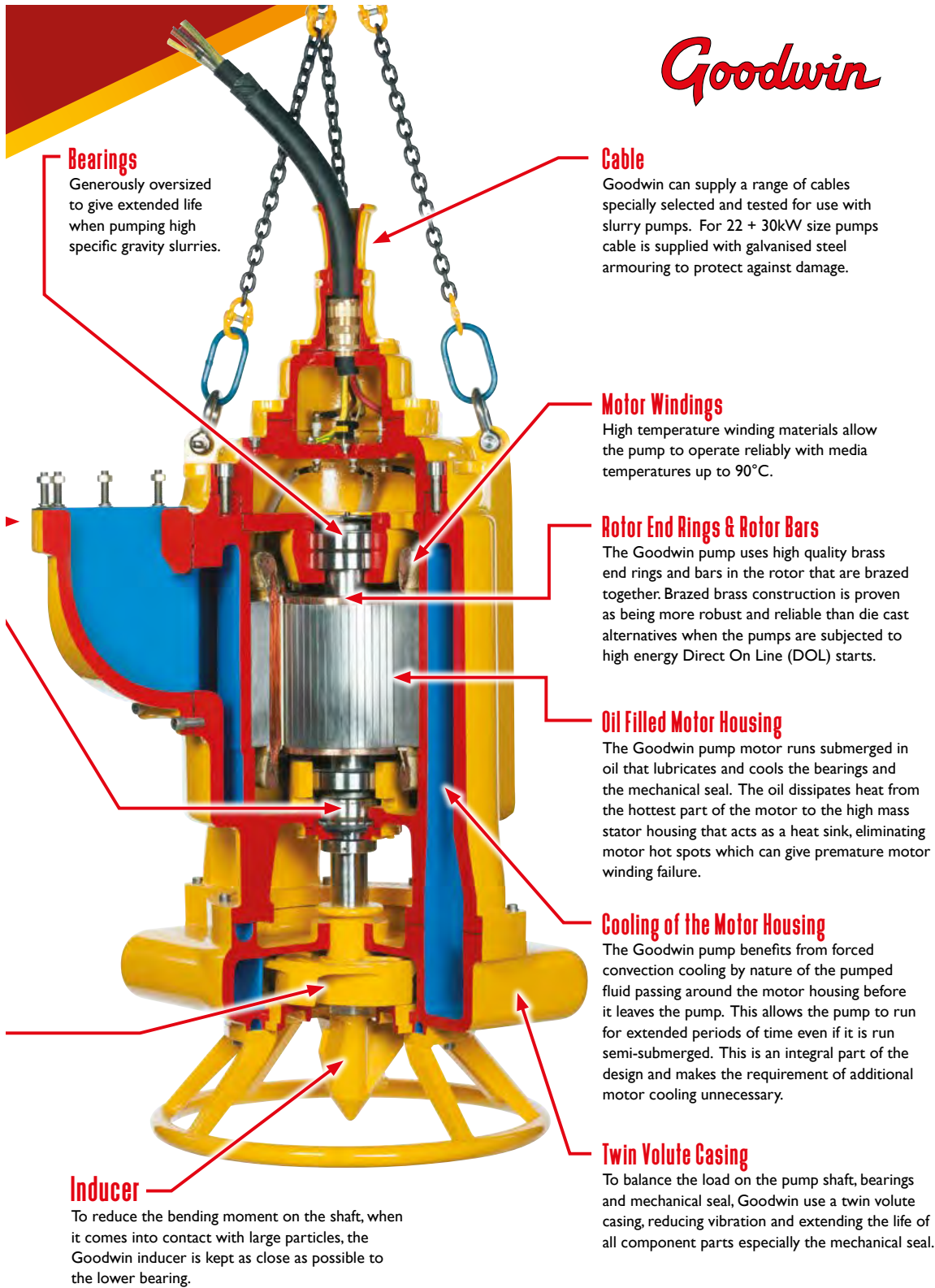

Bearings

Generously oversized to give extended life when pumping high specific gravity slurries.

Cable

Goodwin can supply a range of cables specially selected and tested for use with slurry pumps. For 22 + 30kW size pumps cable is supplied with galvanised steel armouring to protect against damage.

Motor Windings

High temperature winding materials allow the pump to operate reliably with media temperatures up to 90°C.

Rotor End Rings & Rotor Bars

The Goodwin pump uses high quality brass end rings and bars in the rotor that are brazed together. Brazed brass construction is proven as being more robust and reliable than die cast alternatives when the pumps are subjected to high energy Direct On Line (DOL) starts.

Oil Filled Motor Housing

The Goodwin pump motor runs submerged in oil that lubricates and cools the bearings and the mechanical seal. The oil dissipates heat from the hottest part of the motor to the high mass stator housing that acts as a heat sink, eliminating motor hot spots which can give premature motor winding failure.

Cooling of the Motor Housing

The Goodwin pump benefits from forced convection cooling by nature of the pumped fluid passing around the motor housing before it leaves the pump. This allows the pump to run for extended periods of time even if it is run semi-submerged. This is an integral part of the design and makes the requirement of additional motor cooling unnecessary.

Twin Volute Casing

To balance the load on the pump shaft, bearings and mechanical seal, Goodwin use a twin volute casing, reducing vibration and extending the life of all component parts especially the mechanical seal.

Inducer

To reduce the bending moment on the shaft, when it comes into contact with large particles, the Goodwin inducer is kept as close as possible to the lower bearing.





ELECTRIC SUBMERSIBLE SLURRY PUMP CURVES

100mm

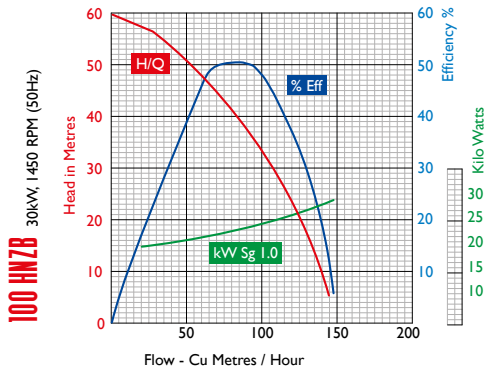
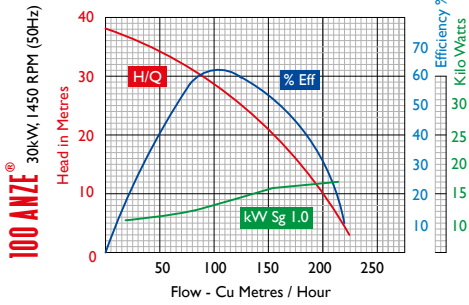
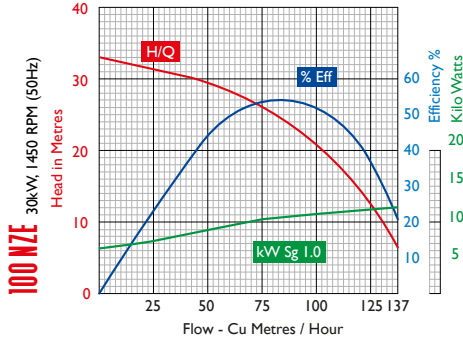

150mm

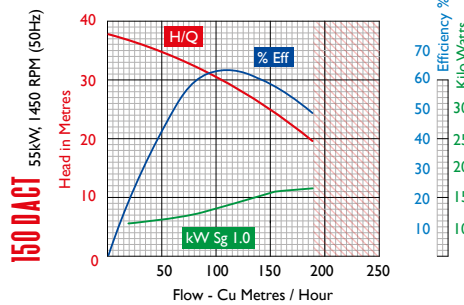
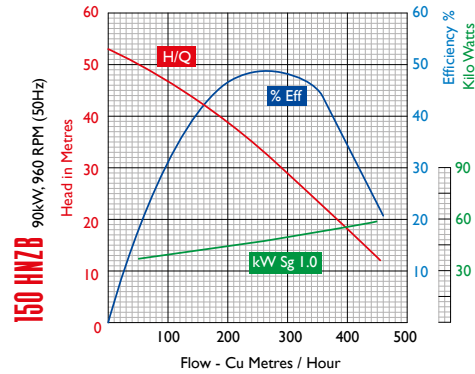
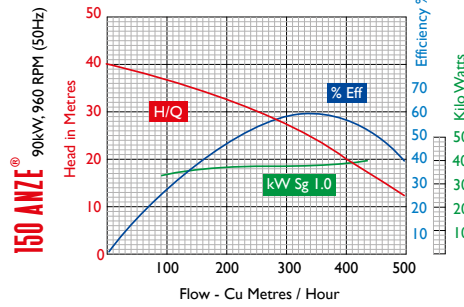
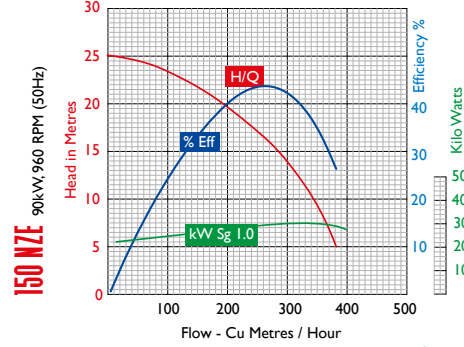



www.GlomacAmerica.com

Goodwin

200mm

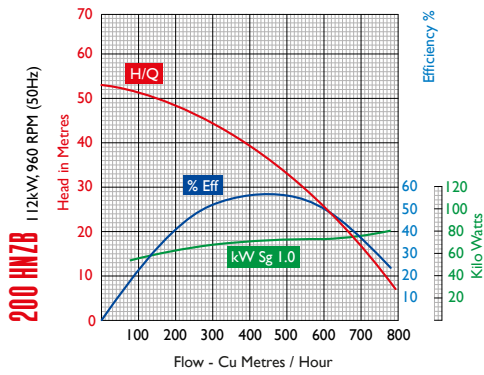
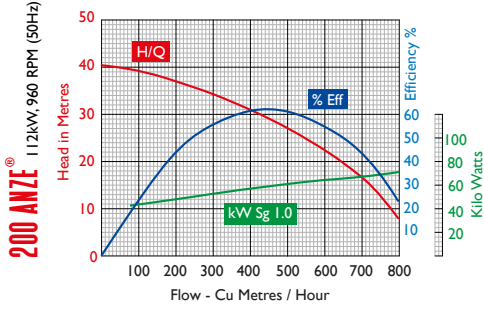
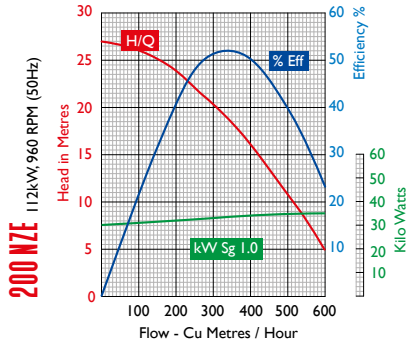

www.GlomacAmerica.com



www.GlomacAmerica.com

ELECTRIC

SUBMERSIBLE SLURRY PUMP DATA

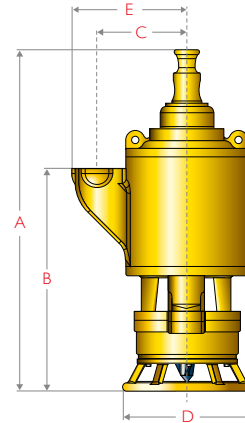

Weights & Dimensions

Pump Size	Power kW	Speed RPM	Weight kg	Dimensions					Outlet Dia. mm
				A	B	C	D	E	
100NZE	22/30	1450	710	1370	915	368	500	475	100
100ANZE®	30	1450	730	1375	920	368	527	475	100
100HNZB	30	1450	770	1370	915	368	657	475	100
100DACT	30	1450	730	1375	920	368	527	475	100
150NZE	90	960	2020	1948	1270	545	857	664	150
150ANZE®	90	960	2050	1938	1260	545	937	664	150
150HNZB	90	960	2060	1987	1309	545	1057	664	150
200NZE	112	960	2300	1970	1323	596	857	771	200
200ANZE®	112	960	2375	1970	1323	596	937	771	200
200HNZB	112	960	2510	2020	1373	596	1057	771	200

All pump designs and information is subject to upgrade and revision.



www.GlomacAmerica.com



Slurry Pump Electrical Data



Electrical Data 100mm

Volts	Full Load Current	Inrush Current Direct on line	No Load Current	Recommended Over Current Protection (A)
-------	-------------------	-------------------------------	-----------------	---

30kW, 1450RPM - 100mm NZE, ANZE® & HNZZ

380V	58 A	300 A	14 A	100 A
415V	54 A	280 A	13 A	100 A
525V	42 A	220 A	10 A	100 A
660V	33 A	170 A	8 A	80 A
1000V	22 A	120 A	6 A	50 A

22kW, 1450RPM - 100mm NZE Only

380V	41 A	215 A	11 A	80 A
415V	38 A	200 A	10 A	80 A
525V	30 A	155 A	8 A	60 A
600V	23 A	120 A	6 A	60 A
1000V	19 A	100 A	5 A	50 A

Outlet Flange Data

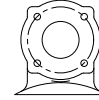

100mm Pump
4" Table 'D'
(Fits 100mm PN10)
M16*2.0P- 4 Places
ø179mm PCD



Electrical Data 150mm

Volts	Full Load Current	Inrush Current Soft Start*	No Load Current	Recommended Over Current Protection (A)
-------	-------------------	----------------------------	-----------------	---

90kW, 960PM - 150mm NZE, ANZE® & HNZZ

380V	171 A	600 A	40 A	350 A
415V	160 A	560 A	38 A	350 A
525V	128 A	450 A	30 A	300 A
660V	97 A	335 A	23 A	300 A
1000V	64 A	225 A	17 A	250 A

55kW, 1450PM - 150mm DACT

380V	115 A	598 A	26 A	160 A
415V	106 A	551 A	24 A	160 A
525V	83 A	432 A	18 A	120 A

Outlet Flange Data

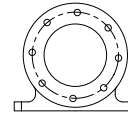

150mm Pump
150mm PN10
M20*2.5P
8 Places
ø240mm PCD



Electrical Data 200mm

Volts	Full Load Current	Inrush Current Soft Start*	No Load Current	Recommended Over Current Protection (A)
-------	-------------------	----------------------------	-----------------	---

112kW, 960PM - 200mm NZE, ANZE® & HNZZ

380V	210 A	735 A	52 A	400 A
415V	190 A	665 A	48 A	400 A
525V	150 A	530 A	39 A	350 A
660V	120 A	420 A	30 A	300 A
1000V	80 A	280 A	23 A	300 A

Outlet Flange Data

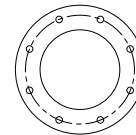

200mm Pump
200mm PN10
M20*2.5P
8 Places
ø295mm PCD

*150 and 200mm pumps are capable of DOL starts should it be necessary.



www.GlomacAmerica.com

DW HH

DIRTY WATER HIGH HEAD
SUBMERSIBLE PUMP

Max Solid Content
10%

Max Media
Temperature
90°C

Max Discharge Pressure
13 bar 100 DW HH
19 bar 150 DW HH

Max Submergence
Depth
28m

The Goodwin DWHH range of pumps are designed for pumping dirty water (defined as water with up to 10% solids) at high pressure. The pumps incorporate all the engineering excellence of Goodwin submersible slurry pumps.

Key features are:

- Low rotational speed gives low wear on components
- Hardened stainless steel impellers resist wear
- Multiple stage closed vane impellers
- Oil filled motor and cooling by the water being pumped allows operation in temperatures up to 90°C
- 28m submergence depth as standard, can be deeper if needed

Many uses for the Goodwin DWHH pump include:

- High wall pumping (open pit) applications
- Construction of buildings, dams & harbour walls
- Long distance pumping applications (up to 4 km)
- Agriculture - irrigation water
- Flood level control - industrial, municipal, mining & marine
- Emergency and environmental control
- Mine dewatering

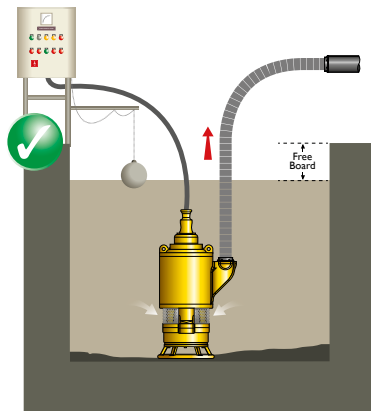

Being a Top Suction pump, the DWHH is able to sit unsupported at the bottom of any sump



www.GlomacAmerica.com



Goodwin DWHH - Technical Information

Electrical Data

Volts	Full Load Current (A)	Inrush Current Soft Start (A)	No Load Current (A)	Recommended Over Current Protection (A)
90kW, 1450RPM - 100mm DWHH				
380V	165	578	39	350
415V	156	546	37	350
525V	124	434	29	300
660V	94	329	22	300
1000V	63	221	17	250
150kW, 1450RPM - 150mm DWHH				
380V	284	994	58	500
415V	261	914	56	400
525V	204	714	45	350
660V	162	567	36	350
1000V	106	371	28	300

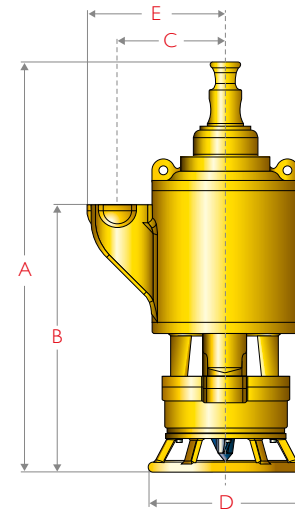
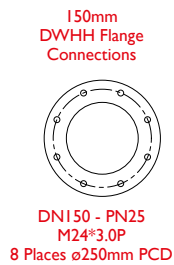
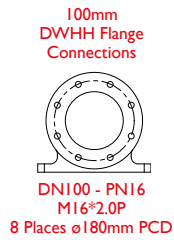

Weights & Dimensions

Pump Size	Power kW	Speed RPM	Weight kg	Dimensions					Outlet Dia. mm	Max Particle mm	Max Flow m ³ /h	Max Head m	Max Slurry Sg kg/l
				A	B	C	D	E					
100 DWHH	90	1450	1940	1898	1220	520	937	630	100	10	195	130	1.1
150 DWHH	150	1450	2750	2015	1368	597	937	747	150	10	195	190	1.1

100 DWHH 90kW, 1450 RPM (50Hz)
Two Stage Pump

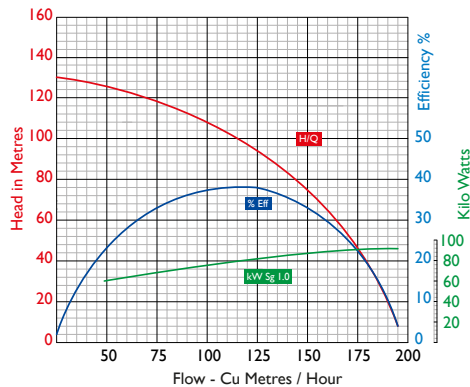

150 DWHH 150kW, 1450 RPM (50Hz)
Three Stage Pump

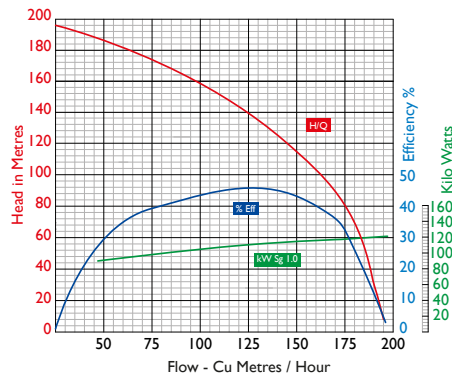



www.GlomacAmerica.com

SDSS

SUPER DUPLEX STAINLESS STEEL ELECTRIC SUBMERSIBLE SLURRY PUMP

Max Solid Content
65%

Max Media
Temperature
90°C

Max Submergence
Depth
28m

The Goodwin Electric Submersible Slurry Pump has been developed into a Super Duplex Stainless Steel (SDSS) variant, intended specifically for acidic applications where there are no reliable alternatives.

The SDSS pump benefits from the same standard features of the Goodwin range of electric submersible slurry pumps

- A motor enclosure which eliminates electrical motor over heating and burnout.
- A motor designed to allow direct online starting even when the pump is embedded in settled solids.
- An integral inducer to re-suspend settled solids.
- A mechanical seal system which is not subjected to the pumped media pressure.
- A cable gland entry and motor configuration which keeps the terminal enclosure separate from the motor enclosure.



snorkel

Xtreme

wheelwash

GLOBE

SUMMIT

Goodwin

Galagos

CASCADE

KLARIVISION

ROBUSTEC

www.GlomacAmerica.com



www.GlomacAmerica.com



Max solid content (by weight)	65%
Max slurry specific gravity kg/l	2.8
Max particle size	32mm
Max slurry temperature	90°C
Max flow m ³ /h	220
Max head (pressure bar)	38m (3.7 bar)
Max submergence depth*	28m

* 28m as standard, can be deeper if required



Goodwin Standard SDSS Construction

	Material	Pitting Resistance (PREn)
Pump Body	Super Duplex Stainless Steel	>40
Fasteners		
Pump Shaft		
Impeller	Cr, Mo, Co alloy with acid resistance and high hardness	Not applicable for this alloy
Inducer		
Wear Plate		
Cable	Fluorethylene propylene FEP	Both chemically and heat resistant
Elastomeric Seals	FEP Encapsulated Viton	Both chemically and heat resistant
Mechanical Seal	Fully Sintered Silicon Carbide	Both chemically and heat resistant
Other	Inconel 625	>45
Other	PTFE	Chemically Inert

As Goodwin manufacture these pumps - should there be any specific material requirements that your process requires; if our standard specification is not already exceeding your requirements, we can manufacture out of any alloy that is readily castable and machinable, should your requirement require different materials of construction.

snorkel

Xtreme

wheelwash

GLOBE

SUMMIT

Goodwin

Galagos

CASCADE

KLARIVISION

ROBUSTEC

www.GlomacAmerica.com



www.GlomacAmerica.com

SUPER DUPLEX STAINLESS STEEL SUBMERSIBLE SLURRY PUMP

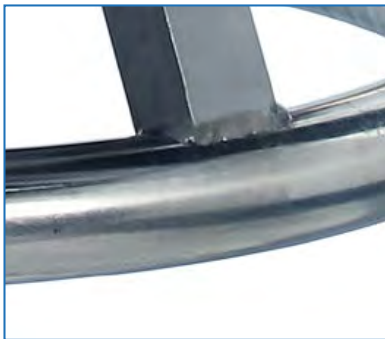

Electrical Data

Volts	Full Load Current	Inrush Current Direct on line	No Load Current	Recommended Over Current Protection (A)
-------	-------------------	-------------------------------	-----------------	---

30kW, 1450RPM - 100mm ANZE®

380V	58 A	300 A	14 A	100 A
415V	54 A	280 A	13 A	100 A
525V	42 A	220 A	10 A	100 A
660V	33 A	170 A	8 A	80 A
1000V	22 A	120 A	6 A	50 A

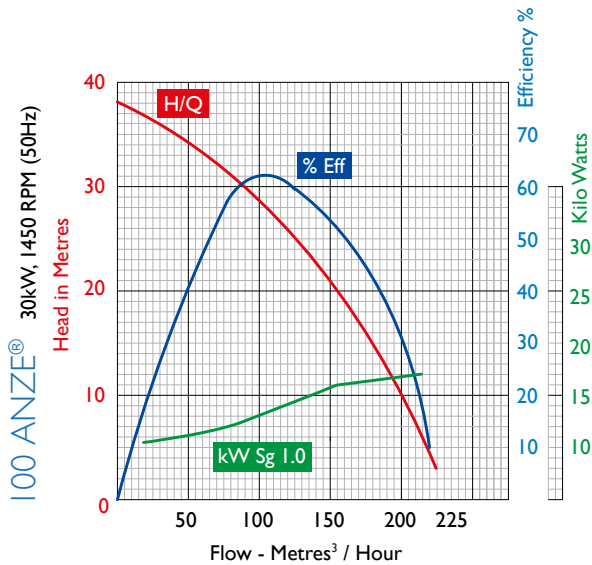

snorkel

Xtreme

wheelwash

GLOBE

SUMMIT

Goodwin

Galagos

CASCADE

KLARIVISION

ROBUSTEC

www.GlomacAmerica.com



The material of construction is shown with a solid red line. It offers good corrosion resistance against both Sulphuric and Hydrochloric Acids, as can be seen in the isocorrosion graphs below.

As this pump can handle slurry – material hardness needs to be taken into consideration as well as the chemical corrosion resistance to provide the best all round solution. Otherwise whilst being corrosion resistant the pump would wear out prematurely by erosion.

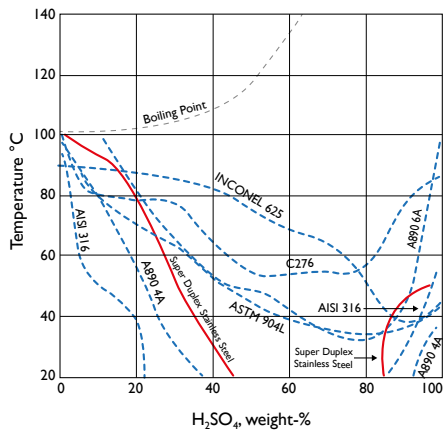

Isocorrosion diagram in naturally aerated sulphuric acid. The curves represent a corrosion rate of 0.1 mm/year (4 mpy) in a stagnant test solution.

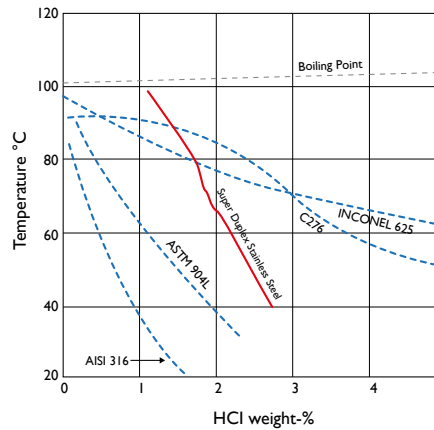

Isocorrosion diagram in naturally aerated hydrochloric acid. The curves represent a corrosion rate of 0.1 mm/year (4 mpy) in a stagnant test solution.

	Chrome	Molybdenum	Nitrogen	PREn (Typical)	Hardness (HB)
Hastelloy C-276**	15	16	-	67.8	180
Inconel 625**	21.5	9	-	51	163
254 SMO	20	6.2	0.2	43.7	147
Super Duplex Stainless Steel*	25	4.1	0.3	43.3	241
904L	20	4.6	-	35	174
A890 Gr 4A	22	3	0.15	34.3	235
AISI 316	16.5	2	-	23.1	179
AISI 304	17.5	-	-	17.5	153

(PRE)n = Cr + 3.3xMo + 16xN

* standard pump construction

** Would be subject to obtaining an export licence

Weights & Dimensions

Pump Size	Power kW	Speed RPM	Weight kg	Dimensions mm			Outlet Dia. mm
				A	B	C	
SDSS 100ANZE®	30	1450	770	1175	527	318	100mm PN10

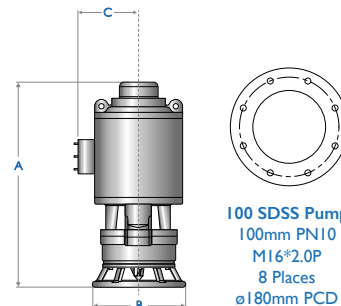

100 SDSS Pump
100mm PN10
M16*2.0P
8 Places
ø180mm PCD



www.GlomacAmerica.com

PONTOONS

SUBMERSIBLE SLURRY PUMP
FLOATING PLATFORMS



Submersible pumps often require
a floating platform.

Goodwin can offer suitable platforms
for our full range of pumps.

Goodwin Standard Pontoon

For smaller applications Goodwin can supply a pontoon with a winch support frame suitable for 100, 150 and 200 series pumps.

All Goodwin pontoons are modular and are easily dismantled for road transport if needed. Assembly on site is quick and straightforward.

Goodwin has a wealth of experience on pontoons and can advise on best practice. Please contact your local sales office to discuss your exact requirements.

Goodwin can
supply a range
of different sized
pontoons
designed for
compatibility
with our range of
submersible
pumps



www.GlomacAmerica.com



www.GlomacAmerica.com



Goodwin Remote Control Dredging Pontoon

For larger applications, Goodwin have developed a dredging pontoon that works with the 200mm range of pumps. Each dredging pontoon is designed for a specific application, features can include:

- remote operation from shore to prevent personnel working in unsafe environments
- propulsion systems
- on board booster pumps
- umbilical or on board power supply
- fully automatic slurry volume/mass control

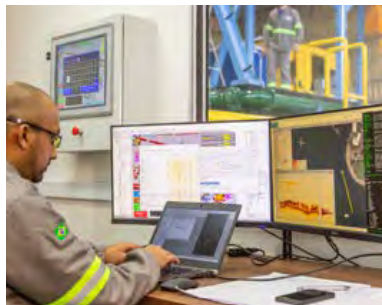

snorkel

Xtreme

wheelwash

GLOBE

SUMMIT

Goodwin

Gallagos

CASCADE

KLARIVISION

ROBUSTEC

www.GlomacAmerica.com



ACCESSORIES

ELECTRICAL PUMP CONTROL PANELS

ON/OFF

Featuring:

- Direct on line (DOL) starting
- Voltage protection
- Earth leakage detection
- IP65 construction
- Emergency stop

AUTOMATIC

Featuring:

- Direct on line (DOL) starting
- Voltage protection
- Earth leakage detection
- IP65 construction
- Current overload protection
- Phase imbalance protection
- Phase loss protection
- Manual on/off control
- Float switch on/off control
- Automatic start with timer
- Automatic start with a combination of timer and float switch*
- Warning beacon and audible alarm to warn of start up
- Emergency stop
- Ammeter display

90/112/150kW Panels

- Identical functionality to the 30kW fully automatic panel, except that soft start is the standard starting method
- Variable Speed Drive optional

30kW Panel Options

- Softs Start
- Variable Speed Drive
- Remote pendant operation
- Stainless steel construction
- Data logging

* Float switch not included



90/112/150kW Panel



30kW Automatic Panel





www.GlomacAmerica.com



Lifting Chain

Pumps are supplied as standard with lifting chains. Contact us if you require specific lifting equipment.



Cable

Goodwin can supply suitable heavy duty cable and cable glands for each of our range of pumps.



Hose and Couplings

Goodwin can supply suitable hose and couplings for each of our pumps.



Bespoke Pump Maintenance Tools

Goodwin can supply a range of custom maintenance tools to facilitate pump maintenance and servicing.



Pump Spare Parts

Goodwin can supply spare parts for our full range of pumps through our service centres. Goodwin is also offers a full pump rebuild service if needed.



Wet End Spares Kit

To assist our customers, Goodwin have developed a "Wet-End" spares kit for 100mm pumps which includes all of the necessary items your technicians will need to perform essential periodic maintenance on your Goodwin pump, to ensure reliable operation and the long life of your investment.

The spares kit includes Impeller, Wear Plate, Inducer, Shaft Sleeve, Lock Nut, Spacers, Fasteners.



www.GlomacAmerica.com



PUMP SELECTION DATA

Static Head - This is the vertical height from the surface of the slurry to the point of discharge.

Friction Head - Friction losses occur when pumping slurry through the discharge line, valves and fittings. This is known as 'Friction Head', and needs to be converted from equivalent length of pipe to pumped head (in metres).

Total Dynamic Head (TDH) - This is the 'Static Head' added to the 'Friction Head' then converted into metres.

Pipeline Critical Velocity - The velocity of flow in the pipeline must be kept above a certain minimum value to prevent solids from settling out and blocking the pipe. This velocity can vary between different types of slurry, depending on the Specific Gravity (Sg) of the slurry being pumped. It is also important to remember that whilst it is essential to maintain a minimum velocity, having a velocity that is too high will also create problems such as high friction losses and increased wear on the piping system.

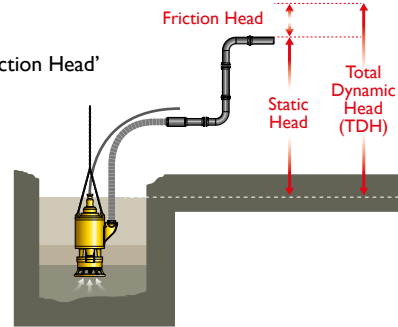

Typical Weights of Dry Materials and Advisable Pipeline Velocities

Material	Density (Sg) Mined	Density (Sg) Processed	Advisable Minimum Pipe Velocity	Advisable Maximum Pipe Velocity
Ash	N/A	0.7 - 1.2	1.5 m/Sec	5 m/Sec
Bauxite	1.8 - 2.5	2.6 - 2.8	2 m/Sec	5 m/Sec
Coal	1.1 - 1.5	1.4 - 1.8	2 m/Sec	5 m/Sec
Copper	1.9 - 4.3	8.8 - 9.0	2 m/Sec	5 m/Sec
Fluorspar	1.7 - 2.9	3.1 - 3.3	2 m/Sec	5 m/Sec
Gold	2.4 - 2.8	19.2 - 19.3	2 m/Sec	5 m/Sec
Iron	2.1 - 5.5	7.0 - 7.9	2 m/Sec	5 m/Sec
Lead	7.3 - 7.6	11.3 - 11.4	2.5 m/Sec	5 m/Sec
Magnetite	2.1 - 5.0	4.9 - 5.2	2 m/Sec	5 m/Sec
Mill Scale	N/A	2.2 - 8.2	2.5 m/Sec	5 m/Sec
Platinum	2.6 - 3.4	21.4 - 21.5	2 m/Sec	5 m/Sec
Sand	1.2 - 1.4	2.6 - 2.7	2 m/Sec	5 m/Sec
Shale	1.5 - 2.0	2.6 - 2.9	2 m/Sec	5 m/Sec
Slag (furnace)	N/A	2.5 - 3.0	2 m/Sec	5 m/Sec
Zinc	3.9 - 4.2	6.9 - 7.2	2 m/Sec	5 m/Sec

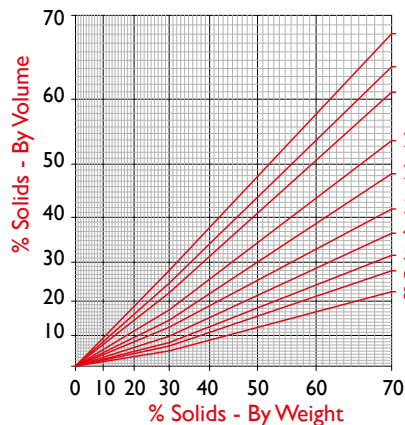

Pipe Diameter	90° Elbow	90° Swept Bend	Gate Valve	Butterfly Valve
80mm/3"	2.3 m	1.3 m	0.6 m	3.5 m
100mm/4"	3.1 m	1.6 m	0.8 m	4.6 m
150mm/6"	4.6 m	2.5 m	1.2 m	6.9 m
200mm/8"	6.1 m	3.2 m	1.6 m	9.1 m
250mm/10"	7.7 m	4.1 m	2.0 m	8.9 m
300mm/12"	9.1 m	4.9 m	2.4 m	10.6 m

Equivalent Length of Straight Pipe created by Pipe Fittings



Pipeline Flow and Velocity for New Steel Pipeline Diameters

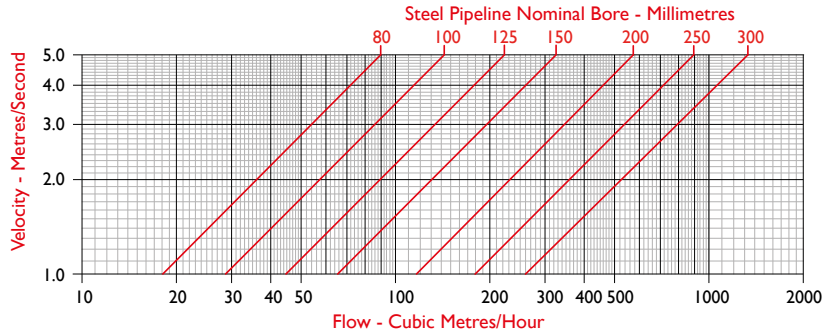

Friction Loss Pumping Water in New Steel Pipeline

Calculated using Hazen Williams method with a coefficient of 140

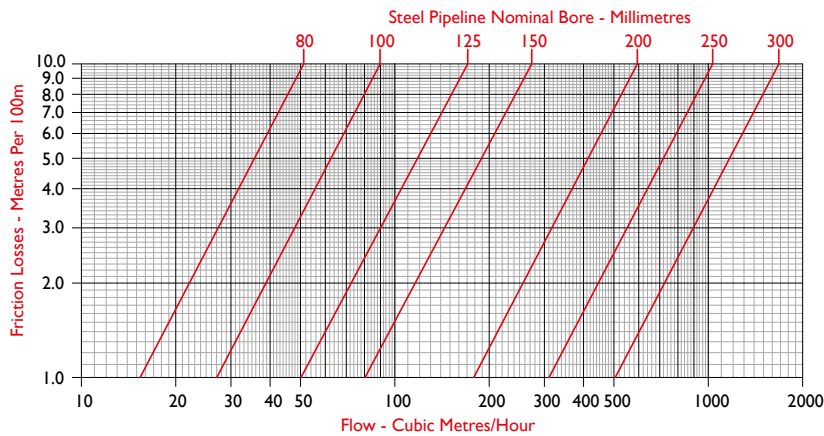

Friction Loss Pumping Slurry in New Steel Pipeline

Calculated using Darcy Weisbach method with a slurry density of 1.35Kg/L and a Darcy Friction Factor of 0.0183

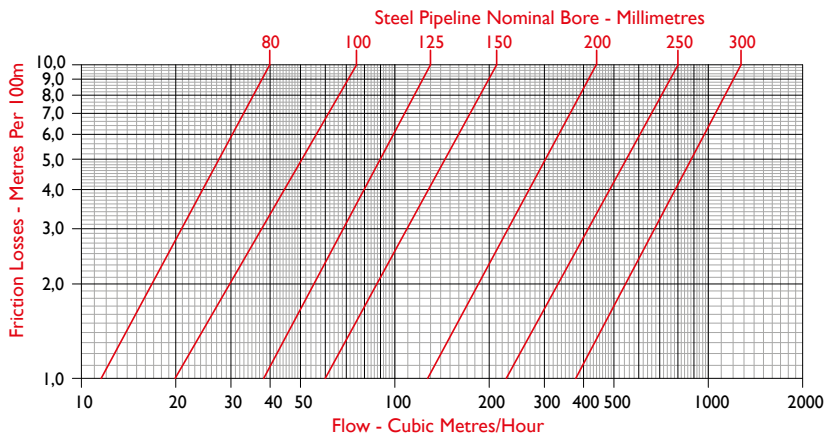



PUMP SELECTION DATA

Field Estimation of Discharge Rate from Open Ended Pipes

Horizontal Distance 'X' mm	Ø D (Pipe Diameter)									
	2"	2.5"	3"	4"	5"	6"	8"	10"	12"	
	50 mm	65 mm	80 mm	100 mm	125 mm	150 mm	200 mm	250 mm	300 mm	
200	11	19	26	46	71	103	183	285	410	m ³ /h
250	14	24	32	57	89	128	228	356	513	m ³ /h
300	17	29	39	68	107	154	274	428	616	m ³ /h
400	23	39	51	91	143	205	365	570	821	m ³ /h
500	28	48	73	114	178	257	456	712	1026	m ³ /h
600		58	88	137	214	307	547	855	1231	m ³ /h
700			102	160	250	359	638	998	1437	m ³ /h
800			117	183	285	410	729	1140	1642	m ³ /h
900			131	206	320	462	821	1283	1847	m ³ /h
1000				228	356	513	912	1425	2053	m ³ /h
1100				250	392	565	1003	1568	2258	m ³ /h

The dark grey shaded area is the advised minimum flow to maintain a pipeline velocity 2m/s

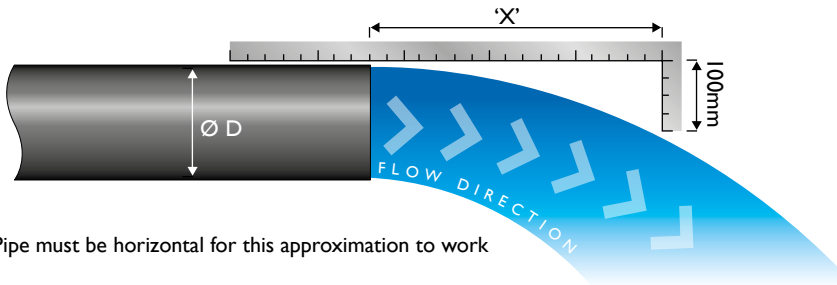

Pipe must be horizontal for this approximation to work

Example: If distance 'X' is 400mm and the discharge pipe used is Ø100mm, then the flow from the pump will be approximately 91 m³/h.



Slurry Nomograph



SGsl = Specific gravity of the slurry
SGs = Specific gravity of the solids

Cv = Concentration of solids by volume
Cm = Concentration of solids by weight

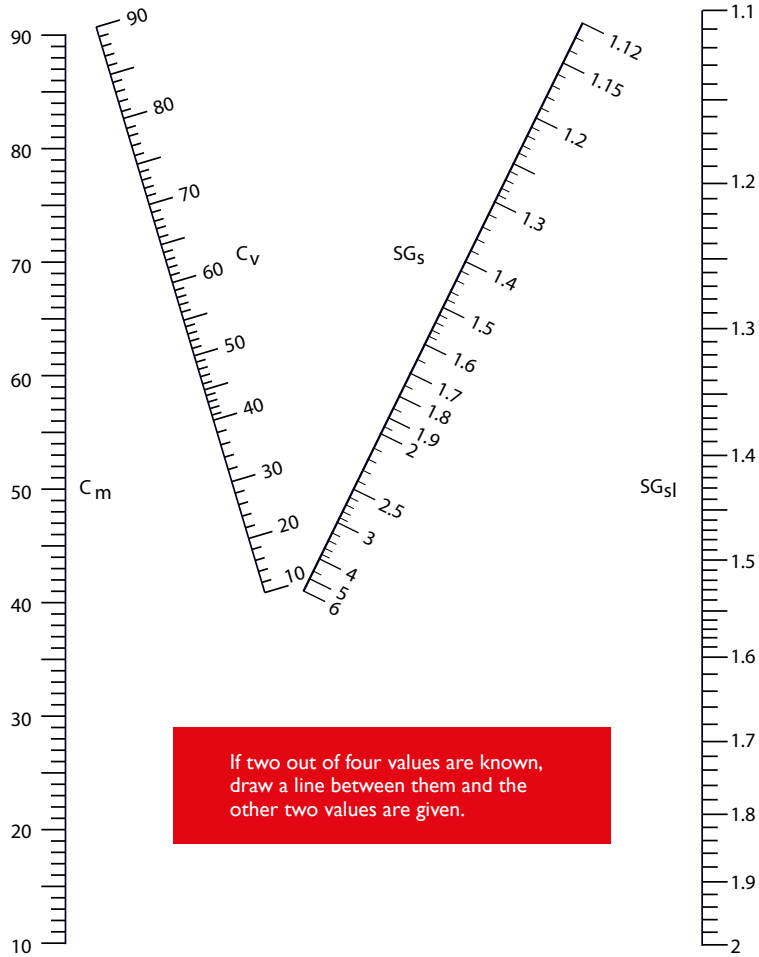

If two out of four values are known, draw a line between them and the other two values are given.

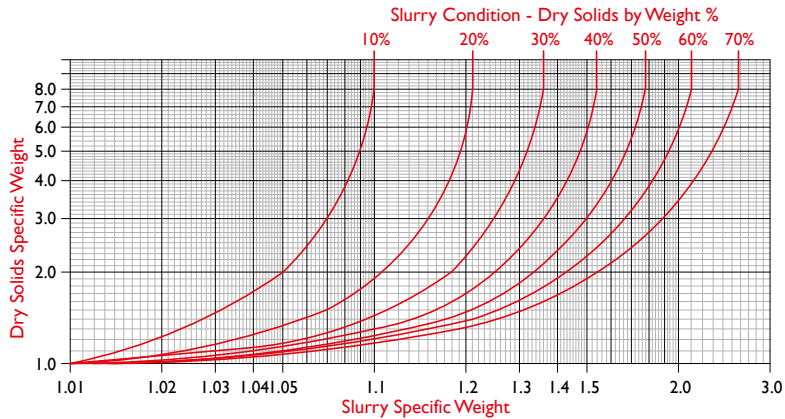



INSTALLATION AND OPERATION BEST PRACTICE

To get the best performance and reliability from a Goodwin Submersible pump, it should be installed according to the best practice outlined below.

Installation Best Practice

Correct Lifting

When moving or suspending the pump, always use certified lifting equipment. Never lift or suspend the pump using the power cable.

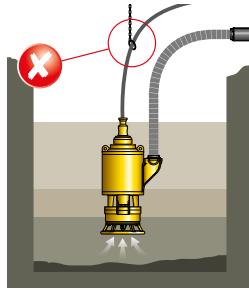

Vertical Positioning

For the best operation of the pump and inducer, ensure that the pump is suspended in a vertical position.

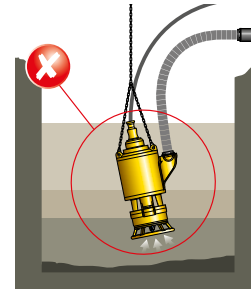

Pump Positioning

When pumping heavy slurries, always suspend the pump with the certified lifting equipment 200mm minimum above the bottom of the sump. Do not let the pump sit on the bottom of the sump.

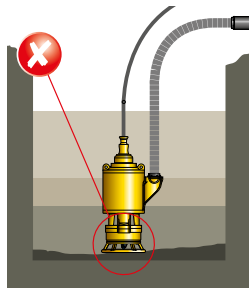

Cable Protection

Make sure that the cable cannot be damaged by the rotating shaft by not allowing too much cable to be released into the slurry.

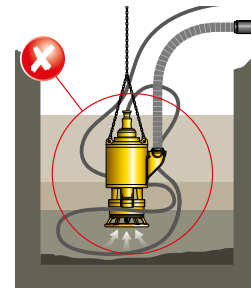

Heavy Duty Flexible Hose Usage

Always use heavy duty flexible hose on the pump discharge. The flexibility of the hose will allow the pump to move on start-up. Do not connect the pump directly to a rigid pipe.

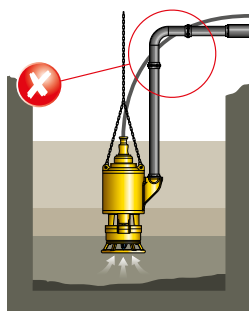

Power Supply & Servicing

Always ensure that the pump is correctly installed by a competent three phase electrician and that the installation incorporates an earth leakage circuit breaker (ELCB)

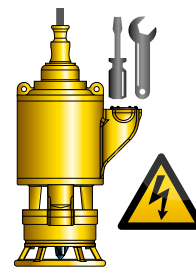



Installing in a Sump

It is important that the sump is not too small for the pump. If the sump is too small, the pump will switch on/off too often which can cause damage to the electric motor. It is best to design a sump to give no more than 10 pump starts per hour.

Example of how to size a sump

Pump Size	100mm/30kW	150mm/90kW	200mm/112kW
Min Sump Size l x w x d (m)	2 x 1.5 x 2	2.5 x 2 x 2.5	3 x 2.5 x 3
Pipe Size mm	100	150	200
Min outflow vol to achieve a minimum pipe velocity of 2m/sec	55 m ³ /h	130 m ³ /h	230 m ³ /h
Actual Sump Size in (m)	l w d	l w d	l w d
	2 1.5 2	2.5 2 2.5	3 2.5 3
Total Sump Capacity = l x w x d (m ³)	A 6.0	12.5	22.5
Actual outflow of Pump (m ³ /h)	B 100	220	450
Sump Free Board depth (m) - Variable according to conditions	C 0.7	0.7	0.7
Dead Zone (m)	D 0.35	0.4	0.45
Sump working Capacity = A-(C x l x w)-(D x l x w) (m ³)	E 2.9	7.0	13.9
Sump Inflow (m ³ /h)	F 20	50	110
Time to fill sump from empty (Minutes) = E / (F/60)	G 8.6	8.4	7.6
Complete cycle time - pumping and resting (Minutes) = (E / ((B-F)/60)) + G Ideally >6 minutes	10.7	10.9	10.0

If assistance is needed for sump sizing, please contact your local representative as each situation can have more than one solution

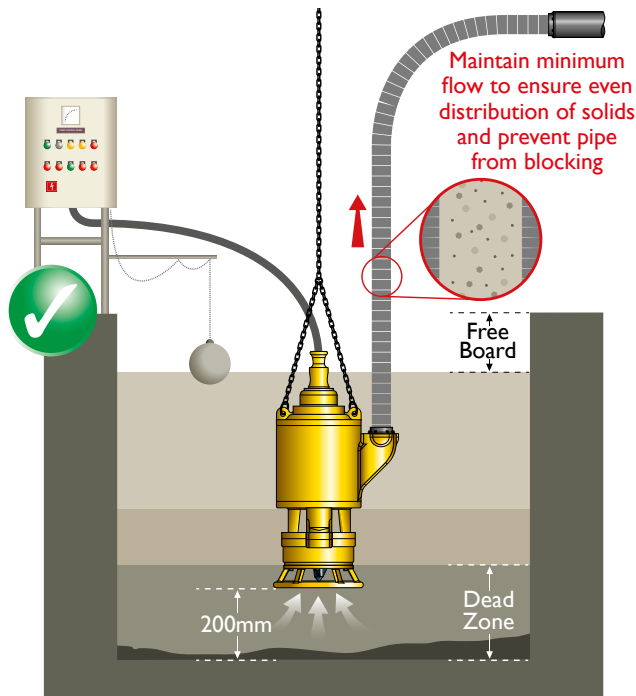

- It is important that the pump is switched off if the sump empties completely.
- If the pump is allowed to run in an empty sump, it will suck in air instead of slurry (sometimes called "snoring").
- As soon as the pump is allowed to suck in air, the flow of slurry in the discharge pipe stops.
- With no velocity in the pipe, heavy slurry particles come out of suspension and fall back down the pipe into the pump wet end.
- If the wet end is still turning, the heavy slurry particles are ground inside the wet end, leading to excessive wear.
- A Goodwin fully automatic control panel (page 17) incorporates low current detection which switches off the pump when the sump is empty. The pump switches back on with either a timer or a float switch as the sump fills. This protects the electric motor and wet end.



www.GlomacAmerica.com

WORKSHOP & REPAIRS



All Goodwin locations are able to offer a full rebuild and repair service for our full range of submersible pumps

All workshops are equip with the correct tools and equipment to strip, repair and rebuild our pumps to original OEM standard.

Our facilities are equipped with test apparatus to ensure all rebuilt pumps are supplied in satisfactory OEM condition.

Goodwin takes great pride in our employees and all workshop staff are fully trained, usually by our in house apprentice programme.

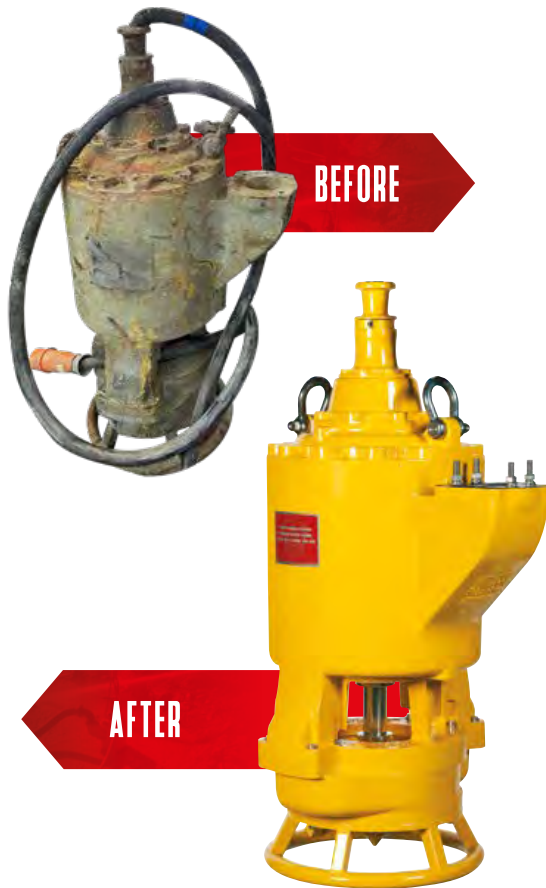
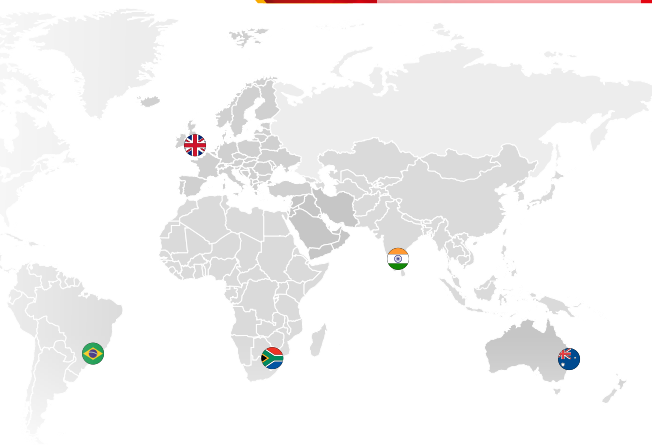

www.GlomacAmerica.com



www.GlomacAmerica.com



26



www.GlomacAmerica.com



www.GlomacAmerica.com

Global Customers

- TATA STEEL
- COAL INDIA LTD
- PT AGINCOURT RESOURCES
- TRONOX
- VALE MINING
- TISCO
- GLENCORE
- CITIC PACIFIC MINING
- NC GEMCO
- BAOGANG GROUP
- MMX
- ALCOA
- DATONG COAL MINE GROUP
- JINDAL GROUP
- CHINA ALUMINIUM Co (CHALCO)
- CSN STEEL
- USIMINAS
- CHN ENERGY
- STEEL AUTHORITY OF INDIA LTD
- CHINACOAL
- LARSEN & TOURBO
- SHANXI COKING COAL GROUP
- KINROSS
- TONGLING NONFERROUS METALS GROUP
- YAMANA GOLD
- JIANGXI COPPER CORPORATION
- SHANDONG GOLD GROUP
- DE BEERS
- ANGLO PLATINUM
- MOPANI COPPER
- EXXARO COAL
- ANGLO GOLD ASHANTI
- IMPALA PLATINUM
- FIRST QUANTUM MINING LTD
- BEAVER GLOBAL
- BHP
- RIO TINTO
- NEW CENTURY ZINC
- NATIONAL THERMAL POWER CORP LTD
- RELIANCE GROUP
- ADANI GROUP
- VENDATA GROUP
- BIRLA GROUP
- NEWCREST MINING

Servicing Global Industry:

- Copper Mining
- Nickel Mining
- Gold Mining
- Coal Mining
- Steel Making
- Power Generation
- Mineral Processing
- Iron Ore Mining
- Alumina Processing
- Platinum Mining
- High Wall Pumping (open pit) Applications
- Construction of Buildings, Dams and Harbour Walls
- Long Distance Pumping Applications
- Agriculture Irrigation



www.GlomacAmerica.com



www.GlomacAmerica.com



UNITED KINGDOM - INDIA - BRASIL - AFRICA - AUSTRALIA

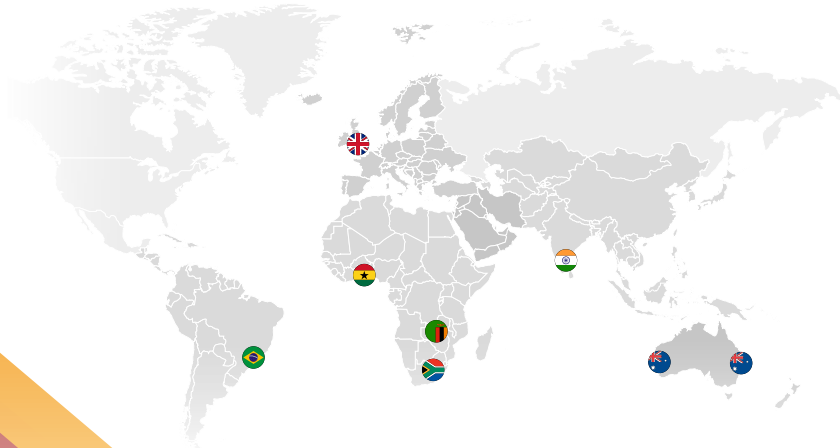

Goodwin



www.GlomacAmerica.com